

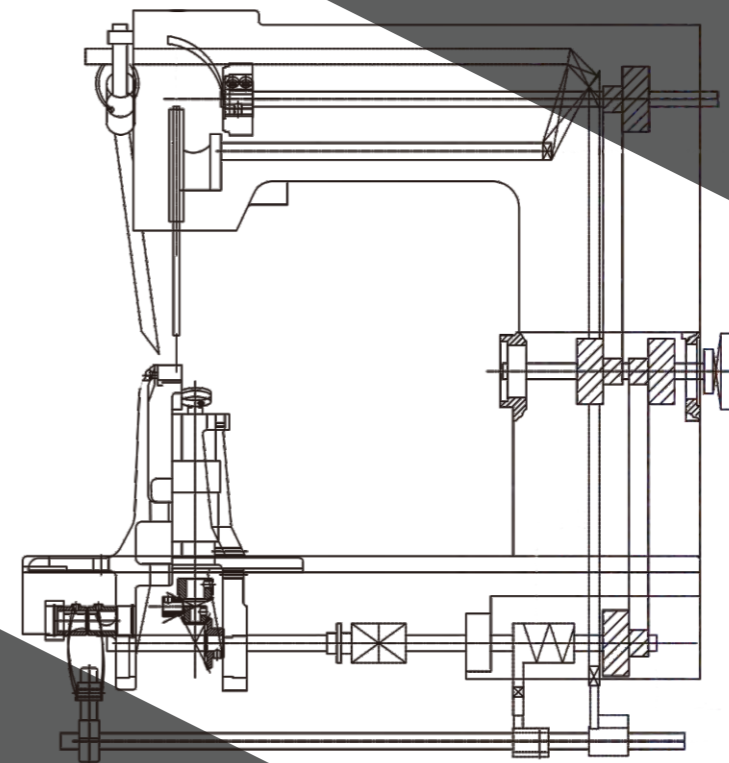

BORN WINNER
—天赢—



Email: purbeck@nbguiaren.com
URL: www.purbeck.net

宁波市浦尔贝缝制机械设备有限公司
NINGBO PURBECK SEWING MACHINE MFG CO.,LTD

宁波市浦尔贝缝制机械设备有限公司
NINGBO PURBECK SEWING MACHINE MFG CO.,LTD

公司简介

Company Profile

宁波市浦尔贝缝制机械设备有限公司主营各类工业用缝纫机及其他鞋机设备, 箱包, 鞋服等的进出口专业外贸公司。并有自己独立的缝纫机生产工厂。公司旗下有自主创立的缝纫机品牌: “天赢®”, “建名®”, 均在缝纫机行业有出色的表现, 在深耕国内市场的同时, 努力拓展海外市场, 产品远销东南亚, 欧美等多个国家和地区。宁波市浦尔贝缝制机械设备有限公司以良好的信誉, 优越的品质, 合理的价格得到了国内外客户的信赖, 深受客户好评。

NINGBO PURBECK SEWING MACHINE MFG CO.,LTD is a foreign trade company who engaged in industrial sewing machine and other shoemachine equipment, suitcase bags and clothes on the import and export. We have our own independent sewing machine factory. Our company founded two independent brand: “BORNWINNERI®” & “ENNOBLE®”, both have a good performance in sewing machine industry. We strive to expand overseas market, and make effort on domestic market at the same time. Products are exported to southeast Asia, Europe, USA and other countries and regions. NINGBO PURBECK SEWING MACHINE MFG CO.,LTD win the trust from customers at home and abroad with good reputation and reasonable price.



CONTENTS 目录

立柱车系列

Pillar Sewing Machine Series

BW-901/BW-901H	01
BW-902/BW-902H	01
BW-9910/BW-9910H	02
BW-9920/BW-9920H	02
BW-9900	03
BW-901T/902T	03
BW-901BTF/BW-902BTF	04
BW-901BT/BW-901BTH/BW-G6/BW-G6-D	05-06
BW-902BT/BW-902BTH	07
BW-1901BT/BW-1901BTH/BW-G6-L/BW-G6-DL	08
BW-1902BT/BW-1902BTH	09
BW-8689/BW-8689-1	11
BW-G7-K/BW-G8	12
BW-G8L/BW-G98L	13
BW-8365/BW-8367	14

曲折缝系列

Zigzag Sewing Machine Series

BW-20U43/53/63/93/BW-20U93Z	15
BW-20U-A2/BW-1530/1533/1534	16
BW-1530Z/BW-1530BT	17
BW-2530/BW-2530Z	18
BW-2150/BW-2150Z	19
BW-3150/BW-3250/BW-335A/BW-335B	20

筒式车系列

Cylinder Bed Sewing Machine Series

BW-335N/BW-PF335	21
BW-2688/BW-2688Z	22
BW-8B/BW-8B-A2	23
BW-246/BW-246Z	24

修边机系列

Trimming Machine Series

BW-341/BW-323	25
BW-323Z	26

削皮机系列

Skiving Machine Series

BW-801	26
BW-801H/BW-801Z	27

平包绷系列

Lockstitch Overlock Interlock Sewing Machine Series

BW-0302/BW-0303Z	28
BW-0303D/BW-0303M	29
BW-747NF/BW-500	30
BW-3802Z/BW-3812	31
BW-9800D/BW-9800Z	32

特种机

Special Sewing Machine Series

BW-600/BW-600N	33
BW-600Z/BW-600T	34
BW-4400/BW-4420 (L180/L457/L635)	35

整套

Full Set Samples

BW-300D/BW-1000D	36
------------------	----

零部件

罗拉车部分零件	37-38
BT零件	39-42
323(902)零件	43
335零件	44
600零件	45
801零件	46
1530/2530/2150零件	47-48
2688零件	49

BW-901

单针直驱罗拉车
Single Needle Direct Drive Roller Machine

BW-901H

单针直驱大梭粗线罗拉车(可选配是否粗线功能)
Single Needle Direct Drive Roller Machine & Large Hook And Thick Thread (thick Thread Fuction As Option)



特点/Character:

- 采用齿轮送及针送式轮钱,压脚,爬坡时仍能保持一定缝目。力保平滑均匀,不起皱,不曲形。
- 采用直驱马达,使机头和马达一体,不占空间,外形更加美观,车缝更加平稳。且非常节能省电。
- 双滚轮式车缝利于操作上下皮料,水平针距稳固,爬坡力强。
- The combined action of wheel and needle ensures constant stitches on both thick and thin sewing operation.The stitch will not bewrinkled , no distortion.
- Use direct drive motor, make machine head and motor together, save space , looks more beautiful and sew more steady. very energyefficient.
- The over load Clutch,used for protect hook.
- The twin rollers make the sewing fasten smooth and be able to climb the thick materials.

用途/Usage:

- 适用于缝制皮鞋,运动鞋,婴儿鞋,包袋,手套,帽子等中厚料物品。
- It available for sewing on medium heavy weight articles with small radius, such as leather shoes,sports shoes, baby shoes, handbags, gloves, caps, etc.

参数/Parameter :

最高缝速	最大缝目	机针
Max Sewing Speed	Max Stitch Length	Needle
2500 S.P.M	7MM	DPX5

BW-902

双针直驱罗拉车
Double Needle Direct Drive Roller Machine

BW-902H

双针直驱大梭粗线罗拉车(可选配是否粗线功能)
Double Needle Direct Drive Roller Machine & Large Hook And Thick Thread (thick Thread Fuction As Option)



特点/Character:

- 采用齿轮送及针送式轮钱,压脚,爬坡时仍能保持一定缝目。力保平滑均匀,不起皱,不曲形。
- 采用直驱马达,使机头和马达一体,不占空间,外形更加美观,车缝更加平稳。且非常节能省电。
- 双滚轮式车缝利于操作上下皮料,水平针距稳固,爬坡力强。
- The combined action of wheel and needle ensures constant stitches on both thick and thin sewing operation.The stitch will not bewrinkled , no distortion.
- Use direct drive motor, make machine head and motor together, save space , looks more beautiful and sew more steady. very energyefficient.
- The over load Clutch,used for protect hook.
- The twin rollers make the sewing fasten smooth and be able to climb the thick materials.

用途/Usage:

- 适用于缝制皮鞋,运动鞋,婴儿鞋,包袋,手套,帽子等中厚料物品。
- It available for sewing on medium heavy weight articles with small radius, such as leather shoes,sports shoes, baby shoes, handbags, gloves, caps, etc.

参数/Parameter :

最高缝速	最大缝目	机针
Max Sewing Speed	Max Stitch Length	Needle
2500 S.P.M	5MM	DPX5

BW-9910

单针罗拉车
Single Needle Roller Machine

BW-9910H

单针梭粗线罗拉车(可选配是否粗线功能)
Single Needle Roller Machine & Large Hook And Thick Thread (thick Thread Fuction As Option)



特点/Character:

- 采用齿轮送及针送式轮钱,压脚,爬坡时仍能保持一定缝目。力保平滑均匀,不起皱,不曲形。
- 双滚轮式车缝利于操作上下皮料,水平针距稳固,爬坡力强。
- 新型针柱座,加固定座,在缝纫时较稳定,减少断针及断线,并可缝纫较整齐美观的线路。
- The combined action of wheel and needle ensures constant stitches on both thick and thin sewing operation.The stitch will not bewrinkled , no distortion.
- The twin rollers make the sewing fasten smooth and be able to climb the thick materials.
- Needle clamp with an extra setting plate, let sewn are stably.Several sewntogether & ensure less discrepancy in stitching.

用途/Usage:

- 适用于缝制皮鞋,运动鞋,婴儿鞋,包袋,手套,帽子等中厚料物品。
- It available for sewing on medium heavy weight articles with small radius, such as leather shoes,sports shoes, baby shoes, handbags, gloves, caps, etc.

参数/Parameter :

最高缝速	最大缝目	机针
Max Sewing Speed	Max Stitch Length	Needle
2500 S.P.M	7MM	DPX5

BW-9920

双针罗拉车
Double Needle Roller Machine

BW-9920H

双针大梭粗线罗拉车(可选配是否粗线功能)
Double Needle Roller Machine & Large Hook And Thick Thread (thick Thread Fuction As Option)



特点/Character:

- 采用齿轮送及针送式轮钱,压脚,爬坡时仍能保持一定缝目。力保平滑均匀,不起皱,不曲形。
- 双滚轮式车缝利于操作上下皮料,水平针距稳固,爬坡力强。
- 新型针柱座,加固定座,在缝纫时较稳定,减少断针及断线,并可缝纫较整齐美观的线路。
- The combined action of wheel and needle ensures constant stitches on both thick and thin sewing operation.The stitch will not bewrinkled , no distortion.
- The twin rollers make the sewing fasten smooth and be able to climb the thick materials.
- Needle clamp with an extra setting plate, let sewn are stably.Several sewntogether & ensure less discrepancy in stitching.

用途/Usage:

- 适用于缝制皮鞋,运动鞋,婴儿鞋,包袋,手套,帽子等中厚料物品。
- It available for sewing on medium heavy weight articles with small radius, such as leather shoes,sports shoes, baby shoes, handbags, gloves, caps, etc.

参数/Parameter :

最高缝速	最大缝目	机针
Max Sewing Speed	Max Stitch Length	Needle
2500 S.P.M	5MM	DPX5

BW-9900

立柱式修边机

Postbed Roller Feed Lockstitch Sewing Machine With Fabric Cutter



特点/Character:

- ◎ 立柱式,用于更多皮革材料切割,操作简单方便。
- ◎ 用于鞋面修边,鞋底毛边修剪。
- ◎ 用于鞋面和箱包适当大范围的材料切割。
- ◎ Post bed type. Used for cutting all kinds of leather. Easy and convenient to operate.
- ◎ Used for trimming shoes uppers and raw edges of soles
- ◎ Suitable for cutting large area of material for shoe uppers and luggage bags.

用途/Usage:

- ◎ 适用于各种皮革材料(箱包鞋类等)
- ◎ Suitable for all kinds of leather (shoes, luggage bags etc)

参数/Parameter:

节能马达	转速
Energy Saving Motor	Speed
550w or 750w	2000-2500 S.P.M

BW-901T

单剪线单针直驱罗拉车

Single needle automatic computerized roller machine & Just thread cutting fuction

BW-902T

单剪线双针直驱罗拉车

Double Needle Automatic Computerized Roller Machine & Just Thread Cutting Fuction



特点/Character:

- ◎ 采用伺服直驱电机,节能环保。配套零件采用了优化的运动学原理,保证最佳的缝纫效果。
- ◎ 采用过载离合器,用于保护旋梭。可预设速度。
- ◎ 有节能、上下定针位,自动剪线。
- ◎ Use the servo direct drive motor, energy conservation and environmental protection.The machine parts using the kinematics principle of optimization, ensure the best sewing effect.
- ◎ The overload clutch, used for protection of the hook.Can chose the preset speed.
- ◎ With energy saving, auto Tangent .

用途/Usage:

- ◎ 特别适用于缝制高档皮鞋,包袋,手套,帽子等弧形中厚料物品。
- ◎ It Especially Available For Sewing On Medium Heavy Weight Articles With Smal Radius, Such As Superior Leather Shoes, Handbags, Gloves.caps,etc.

参数/Parameter:

最高缝速	最大缝目	机针
Max Sewing Speed	Max Stitch Length	Needle
2500 S.P.M	5-7MM	DPX5

BW-901BTF

单针自动电脑罗拉车

Single Needle Automatic Computerized Roller Machine



特点/Character:

- ◎ 采用伺服直驱电机,节能环保。配套零件采用了优化的运动学原理,保证最佳的缝纫效果。
- ◎ 采用过载离合器,用于保护旋梭。可预设速度。
- ◎ 有节能、上下定针位,自动剪线,自动倒缝,自动抬压脚。
- ◎ Use the servo direct drive motor, energy conservation and environmental protection.The machine parts using the kinematics principle of optimization, ensure the best sewing effect.
- ◎ The overload clutch, used for protection of the hook.Can chose the preset speed.
- ◎ With energy saving, auto Tangent, set up and down needle position, auto reverse stitching, auto presser foot.

用途/Usage:

- ◎ 特别适用于缝制高档皮鞋,包袋,手套,帽子等弧形中厚料物品。
- ◎ It especially available for sewing on medium heavy weight articles with small radius, such as superior leather shoes, handbags, gloves, caps, etc.

参数/Parameter:

最高缝速	最大缝目	机针
Max Sewing Speed	Max Stitch Length	Needle
2500 S.P.M	7MM	DPX5

BW-902BTF

双针自动电脑罗拉车

Double Needle Automatic Computerized Roller Machine



特点/Character:

- ◎ 采用伺服直驱电机,节能环保。配套零件采用了优化的运动学原理,保证最佳的缝纫效果。
- ◎ 采用过载离合器,用于保护旋梭。可预设速度。
- ◎ 有节能、上下定针位,自动剪线。
- ◎ Use the servo direct drive motor, energy conservation and environmental protection.The machine parts using the kinematics principle of optimization, ensure the best sewing effect.
- ◎ The overload clutch, used for protection of the hook.Can chose the preset speed.
- ◎ With energy saving, auto Tangent .

用途/Usage:

- ◎ 特别适用于缝制高档皮鞋,包袋,手套,帽子等弧形中厚料物品。
- ◎ It Especially Available For Sewing On Medium Heavy Weight Articles With Smal Radius, Such As Superior Leather Shoes, Handbags, Gloves.caps,etc.

参数/Parameter:

最高缝速	最大缝目	机针
Max Sewing Speed	Max Stitch Length	Needle
2500 S.P.M	5MM	DPX5



BW-901BT

单针自动电脑罗拉车
Single Needle Automatic Computerized Roller Machine

BW-901BTH

单针电脑大梭粗线罗拉车(可选配是否粗线功能)
Single Needle Roller Machine & Large Hook And Thick Thread (thick Thread Fuction As Option)

BW-G6

单针电脑罗拉车&短线头
Single Needle Automatic Computerized Roller Machine&short Threads

BW-G6-D

单针电脑罗拉车&大梭短线头
Single Needle Automatic Computerized Roller Machine&large hook and short Threads

特点/Character:

- 采用伺服直驱电机,节能环保。配套零件采用了优化的运动学原理,保证最佳的缝纫效果。
- 采用过载离合器,用于保护旋梭。可预设速度。
- 有节能、上下定针位,自动剪线,自动倒缝,自动抬压脚。
- 减少换线频率提高生产效率(901BT)
- 可以车常规装饰线(901BTH)
- Use The Servo Direct Drive Motor, Energy Conservation And Environmental Protection.the Machine Parts Using The Kinematics Principle Of Optimization, Ensure The Best Sewing Effect.
- The Overload Clutch, Used For Protection Of The Hook.can Chose The Preset Speed.with Energy Saving, Auto Stitching, Auto Presser Foot.
- Can Reduce Numbers Of Bobbin Changes, Increase Productivity.(901BT BW-G6-D)
- Regular Decorative Lines Are Available.(901BTH BW-G6-D)

用途/Usage:

- 特别适用于缝制高档皮鞋,包袋,手套,帽子等弧形中厚料物品。
- Lt Especially Available For Sewing On Medium Heavy Weight Articles With Small Adius, Such As Superior Leather Shoes, Handbags, Gloves,caps, Etc.

参数/Parameter:

最高缝速	最大缝目	机针
Max Sewing Speed	Max Stitch Length	Needle
2500 S.P.M	7MM	DPX5

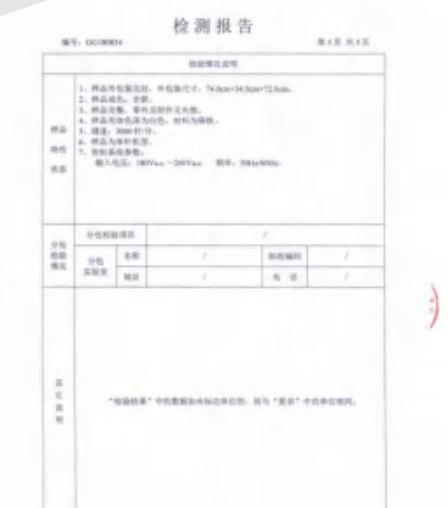
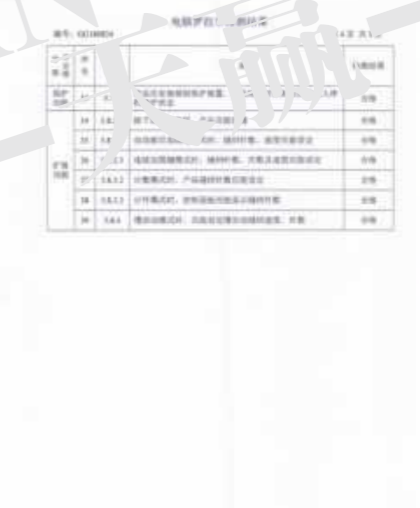
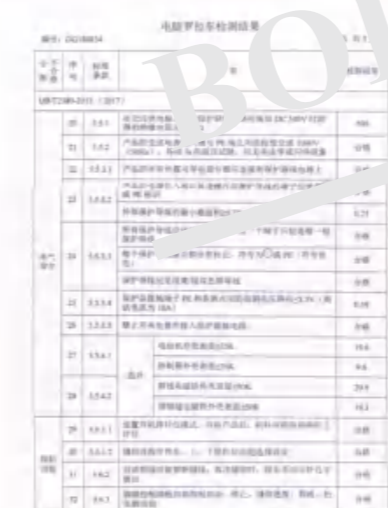
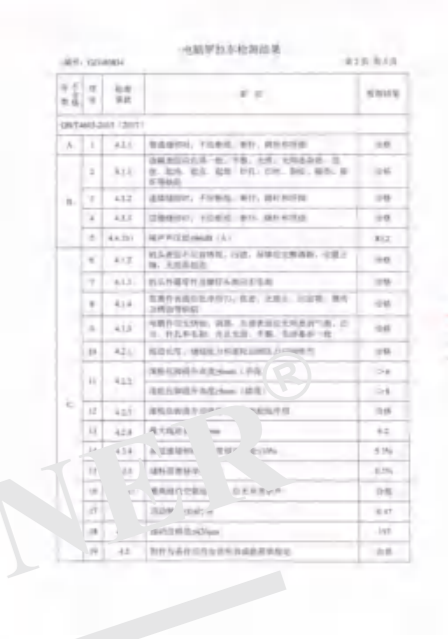



BW-902BT

双针自动电脑罗拉车
Double Needle Automatic Computerized Roller Machine

BW-902BTH

双针大梭粗线罗拉车(可选配是否粗线功能)
Double Needle Roller Machine & Large Hook And Thick Thread (thick Thread Function As Option)



BW-1901BT

单针步进款电脑罗拉车
Single Needle Step Motor Computer Roller Machine

BW-1901BTH

单针大梭粗线步进款电脑罗拉车(可选配是否要粗线功能)
Single Needle Step Motor Computer Roller Machine & large hook and thick thread (thick thread function as option)

BW-G6-L

单针步进款电脑罗拉车&短线头
Single Needle Step Motor Computer Roller Machine & short threads

BW-G6-DL

单针大梭步进款电脑罗拉车&短线头
Single Needle Step Motor Computer Roller Machine & large hook and short threads

特点/Character:

- 采用伺服直驱电机,节能环保。配套零件采用了优化的运动学原理,保证最佳的缝纫效果。
- 采用过载离合器,用于保护旋梭。可预设速度。
- 有节能、上下定针位,自动剪线,自动倒缝,自动抬压脚。
- 减少换线频率提高生产效率(902BTH)
- 可以车常规装饰线(902BTH)
- Use The Servo Direct Drive Motor, Energy Conservation And Environmental Protection.the Machine Parts Using The Kinematics Principle Of Optimization, Ensure The Best Sewing Effect.
- The Overload Clutch, Used For Protection Of The Hook.can Chose The Preset Speed.with Energy Saving, Auto Tangent, Set Up And Down Needle Position, Autoreverse Stitching, Auto Presser Foot.
- Can Reduce Numbers Of Bobbin Changes, Increase Productivity.(902BTH)
- Regular Decorative Lines Are Available.(902BTH)

用途/Usage:

- 特别适用于缝制高档皮鞋,包袋,手套,帽子等弧形中厚料物品。
- Lt Especially Available For Sewing On Medium Heavy Weight Articles With Small Adius, Such As Superior Leather Shoes, Handbags, Gloves,caps, Etc.

参数/Parameter:

最高缝速	最大缝目	机针
Max Sewing Speed	Max Stitch Length	Needle
2500 S.P.M	5MM	DPX5

特点/Character:

- 采用伺服直驱电机,节能环保。配套零件采用了优化的运动学原理,保证最佳的缝纫效果。
- 采用过载离合器,用于保护旋梭。可预设速度。
- 有节能、上下定针位,自动剪线,自动倒缝,自动抬压脚。
- 采用伺服步进电机传动结构,减少组装配件,机器性能更稳定,前后重针效果更佳声音轻,生产效率更高。
- 切线后线头长度为3MM无需再次修剪,减少人工时间提高生产效率。(BW-G6-L BW-G6-DL)采用双倍大釜减少换梭心时间提高生产效率(BW-G6-DL)
- Use the servo direct drive motor, energy conservation and environmental protection. The machine parts using the kinematics principle of optimization, ensure the best sewing effect.
- The overload clutch, used for protection of the hook.Can chose the preset speed.
- With energy saving, auto Tangent, set up and down needle position, auto reverse stitching, auto presser foot.
- Using servo step motor transmission structure, reduce assembly accessories. The mechanical properties is more stable. Good effect on back stitch sewing.Low noise and high on productivity.
- 3mm short threads, no manual trimming required, increasing productivity.(Bw-G6-1 BW-G6-DL)2 times large hook equipped to reduce numbers of bobbin changes, increasing productivity (BW-G6-DL)

用途/Usage:

- 特别适用于缝制高档皮鞋,包袋,手套,帽子等弧形中厚料物品。
- Lt Especially Available For Sewing On Medium Heavy Weight Articles With Small Adius, Such As Superior Leather Shoes, Handbags, Gloves,caps, Etc.

参数/Parameter:

最高缝速	最大缝目	机针
Max Sewing Speed	Max Stitch Length	Needle
2500 S.P.M	7MM	DPX5



BW-1902BT

双针步进款电脑罗拉车
Double Needle Step Motor Computer Roller Machine

BW-1902BTH

双针大梭粗线步进电脑罗拉车(可选配是否要粗线功能)
Double Needle Step Motor Computer Roller Machine & large hook and thick thread (thick thread function as option)

特点/Character:

- 采用伺服直驱电机,节能环保。配套零件采用了优化的运动学原理,保证最佳的缝纫效果。
- 采用过载离合器,用于保护旋梭。可预设速度。
- 有节能、上下定针位,自动剪线,自动倒缝,自动抬压脚。
- 采用伺服步进电机传动结构,减少组装配件,机器性能更稳定,前后重针效果更佳声音轻,生产效率更高。
- 采用双倍大釜减少换梭心时间提高生产效率(BW-1902BTH)
- Use the servo direct drive motor, energy conservation and environmental protection. The machine parts using the kinematics principle of optimization, ensure the best sewing effect.
- The overload clutch, used for protection of the hook. Can chose the preset speed.
- With energy saving, auto Tangent, set up and down needle position, auto reverse stitching, auto presser foot.
- Using servo step motor transmission structure, reduce assembly accessories. The mechanical properties is more stable. Good effect on back stitch sewing. Low noise and high on productivity.
- 2times large. hook equipped. to reduce numbers of bobbin. changes. increasing productivity. (BMW.1902BTH).

用途/Usage:

- 特别适用于缝制高档皮鞋,包袋,手套,帽子等弧形中厚料物品。
- It Especially Available For Sewing On Medium Heavy Weight Articles With Small Radius, Such As Superior Leather Shoes, Handbags, Gloves, caps, Etc.

参数/Parameter:

最高缝速	最大缝目	机针
Max Sewing Speed	Max Stitch Length	Needle
2500 S.P.M	5MM	DPX5

BW-8688

单针滚轮送细小型罗拉车(右釜)
Single Needle Small Roller Feed Postbed Sewing Machine (Right Hook) With Wheel Feed, Needle Feed & Drive



特点/Character:

- 使用小釜设计,适用于立体产品的底部,边线,角隅的缝制,如:手提袋、马靴。
- 采用双滚轮式及针送式轮线,爬坡时能保持一定的缝目。新型针柱座加固底座,车缝效果良好,减少断针及断线。
- Using small hook design, suitable for small caliber, stitching large & three dimensional articles. Example: reticule, leather bag, and boots.
- The combined action of wheel and needle ensures constant stitches in both thick and thin sewing operation.
- Needle clamp with an extra setting plate, let sewn stably, several leather sewn together, ensure less discrepancy in stitching.

用途/Usage:

- 缝制儿童鞋类,皮包,立体产品等。
- Suitable for sewing child shoes, bags, three-dimensional articles etc.

参数/Parameter:

最高缝速	最大缝目	机针
Max Sewing Speed	Max Stitch Length	Needle
2000 S.P.M	7MM	DPX5

BW-8688-1

单针滚轮送细小型罗拉车(左釜)
Single Needle Small Roller Feed Postbed Sewing Machine (Left Hook) With Wheel Feed, Needle Feed & Drive



特点/Character:

- 采用伺服直驱电机,节能环保。配套零件采用了优化的运动学原理,保证最佳的缝纫效果。
- 采用过载离合器,用于保护旋梭。可预设速度。
- 有节能、上下定针位,自动剪线。
- Use the servo direct drive motor, energy conservation and environmental protection. The machine parts using the kinematics principle of optimization, ensure the best sewing effect.
- The overload clutch, used for protection of the hook. Can chose the preset speed.
- With energy saving, auto Tangent.

用途/Usage:

- 特别适用于缝制高档皮鞋,包袋,手套,帽子等弧形中厚料物品。
- It Especially Available For Sewing On Medium Heavy Weight Articles With Small Radius, Such As Superior Leather Shoes, Handbags, Gloves, caps, etc.

参数/Parameter:

最高缝速	最大缝目	机针
Max Sewing Speed	Max Stitch Length	Needle
2000 S.P.M	7MM	DPX5

BW-8689

单针滚轮送细小型罗拉车(右釜)

Single Needle Small Roller Feed Postbed Sewing Machine (Right Hook) With Wheel Feed, Needle Feed & Drive



特点/Character:

- 使用小釜设计,适用于立体产品的底部,边线,角隅的缝制,如:手提袋、马靴。采用双滚轮式及针送式轮钱,爬坡时能保持一定的缝目。新型针柱座加固底座,车缝效果良好,减少断针及断线。
- Using small hook design, suitable for small caliber, stitching large & three dimensional articles. Example: reticule, leather bag, and boots.
- The combined action of wheel and needle ensures constant stitches in both thick and thin sewing operation.
- Needle clamp with an extra setting plate, let sewn stably, several leather sewn together, ensure less discrepancy in stitching.

用途/Usage:

- 缝制鞋类,皮包,立体产品等。
- Suitable for sewing shoes, bags, three-dimensional articles etc.

参数/Parameter:

最高缝速	最大缝目	机针
Max Sewing Speed	Max Stitch Length	Needle
2000 S.P.M	7MM	DPX5

BW-8689-1

单针滚轮送细小型罗拉车(左釜)

Single Needle Small Roller Feed Postbed Sewing Machine (Left Hook) With Wheel Feed, Needle Feed & Drive



特点/Character:

- 使用小釜设计,适用于立体产品的底部,边线,角隅的缝制,如:手提袋、马靴。采用双滚轮式及针送式轮钱,爬坡时能保持一定的缝目。新型针柱座加固底座,车缝效果良好,减少断针及断线。
- Using small hook design, suitable for small caliber, stitching large & three dimensional articles. Example: reticule, leather bag, and boots.
- The combined action of wheel and needle ensures constant stitches in both thick and thin sewing operation.
- Needle clamp with an extra setting plate, let sewn stably, several leather sewn together, ensure less discrepancy in stitching.

用途/Usage:

- 缝制鞋类,皮包,立体产品等。
- Suitable for sewing shoes, bags, three-dimensional articles etc.

参数/Parameter:

最高缝速	最大缝目	机针
Max Sewing Speed	Max Stitch Length	Needle
2000 S.P.M	7MM	DPX5

BW-G7-K

细立柱步进款按键罗拉车(175mm)

Step Motor Type Button Screen Sim Post Bed Roller Feed Sewing Machine (175MM)



特点/Character:

- 采用伺服步进电机传动结构,减少组装配件,机器性能更稳定,前后重针效果更佳声音轻,生产效率更高。
- 使用小釜设计,适用于立体产品的底部,边线,角隅的缝制,如:手提袋、马靴。采用双滚轮式及针送式轮钱,爬坡时能保持一定的缝目。新型针柱座加固底座,车缝效果良好,减少断针及断线。
- Using servo step motor transmission structure, reduce assembly accessories. The mechanical properties is more stable. Good effect on back stitch sewing. Low noise and high on productivity.
- Using small hook design, suitable for small caliber, stitching large & three dimensional articles. Example: reticule, leather bag, and boots.
- The combined action of wheel and needle ensures constant stitches in both thick and thin sewing operation.
- Needle clamp with an extra setting plate, let sewn stably, several leather sewn together, ensure less discrepancy in stitching.

用途/Usage:

- 缝制鞋类,皮包,立体产品等。
- Suitable for sewing shoes, bags, three-dimensional articles etc.

参数/Parameter:

最高缝速	最大缝目	机针
Max Sewing Speed	Max Stitch Length	Needle
2000 S.P.M	7MM	DPX5

BW-G8

细立柱电脑常规款罗拉车(315mm)

Regular Computerized Type Sim Post Bed Roller Feed Sewing Machine (315MM)



特点/Character:

- 采用伺服直驱电机,节能环保。配套零件采用了优化的运动学原理,保证最佳的缝纫效果。
- 采用过载离合器,用于保护旋梭。可预设速度。
- 有节能、上下定针位,自动剪线,自动倒缝,自动抬压脚。
- 使用小釜设计,适用于立体产品的底部,边线,角隅的缝制,如:手提袋、马靴。采用双滚轮式及针送式轮钱,爬坡时能保持一定的缝目。新型针柱座加固底座,车缝效果良好,减少断针及断线。
- Use the servo direct drive motor, energy conservation and environmental protection. The machine parts using the kinematics principle of optimization, ensure the best sewing effect.
- The overload clutch, used for protection of the hook. Can chose the preset speed.
- With energy saving, auto Tangent, set up and down needle position, auto reverse stitching, auto presser foot.
- Using small hook design, suitable for small caliber, stitching large & three dimensional articles. Example: reticule, leather bag, and boots.
- The combined action of wheel and needle ensures constant stitches in both thick and thin sewing operation.
- Needle clamp with an extra setting plate, let sewn stably, several leather sewn together, ensure less discrepancy in stitching.

用途/Usage:

- 缝制鞋类,皮包,立体产品等。
- Suitable for sewing shoes, bags, three-dimensional articles etc.

参数/Parameter:

最高缝速	最大缝目	机针
Max Sewing Speed	Max Stitch Length	Needle
2000 S.P.M	7MM	DPX5

BW-G8L

细立柱步进款触摸屏罗拉车 (315mm)
Step Motor Type Sim Post Bed Touch Screen Roller Feed Sewing Machine (315MM)



特点/Character:

- 采用伺服步进电机传动结构,减少组装配件,机器性能更稳定,前后重针效果更佳声音轻,生产效率更高。
- 使用小釜设计,适用于立体产品的底部,边线,角隅的缝制,如:手提袋、马靴。采用双滚轮式及针送式轮钱,爬坡时能保持一定的缝目。新型针柱座加固底座,车缝效果良好,减少断针及断线。
- Using servo step motor transmission structure, reduce assembly accessories. The mechanical properties is more stable. Good effect on back stitch sewing. Low noise and high on productivity.
- Using small hook design, suitable for small caliber, stitching large & three dimensional articles. Example: reticule, leather bag, and boots.
- The combined action of wheel and needle ensures constant stitches in both thick and thin sewing operation.
- Needle clamp with an extra setting plate, let sewn stably, several leather sewn together, ensure less discrepancy in stitching.

用途/Usage:

- 缝制鞋类,皮包,立体产品等。
- Suitable for sewing shoes, bags, three-dimensional articles etc.

参数/Parameter:

最高缝速	最大缝目	机针
Max Sewing Speed	Max Stitch Length	Needle
2000 S.P.M	7MM	DPX5

BW-G98L

细立柱步进款触摸屏双针罗拉车 (315mm)
Step Motor Type Double Needle Sim Post Bed Touch Screen Roller Feed Sewing Machine (315MM)



特点/Character:

- 采用伺服步进电机传动结构,减少组装配件,机器性能更稳定,前后重针效果更佳声音轻,生产效率更高。
- 使用小釜设计,适用于立体产品的底部,边线,角隅的缝制,如:手提袋、马靴。采用双滚轮式及针送式轮钱,爬坡时能保持一定的缝目。新型针柱座加固底座,车缝效果良好,减少断针及断线。
- Using servo step motor transmission structure, reduce assembly accessories. The mechanical properties is more stable. Good effect on back stitch sewing. Low noise and high on productivity.
- Using small hook design, suitable for small caliber, stitching large & three dimensional articles. Example: reticule, leather bag, and boots.
- The combined action of wheel and needle ensures constant stitches in both thick and thin sewing operation.
- Needle clamp with an extra setting plate, let sewn stably, several leather sewn together, ensure less discrepancy in stitching.

用途/Usage:

- 缝制鞋类,皮包,立体产品等。
- Suitable for sewing shoes, bags, three-dimensional articles etc.

参数/Parameter:

最高缝速	最大缝目	机针
Max Sewing Speed	Max Stitch Length	Needle
2000 S.P.M	5MM	DPX5

BW-8365

单针综合送高头车(左右釜)
Single Needle Union Feed High Post Bed Sewing Machine (Left & Right Hook Side)

双针综合送高头车
Double Needle Union Feed High Post Bed Sewing Machine



特点/Character:

- 采用三同步综合送料方式,根据缝制需要分为左釜座和右釜座。适用于缝制大型立体及小曲度的物品,针距调节,倒缝操作简单方便,线迹稳定美观。
- Using three synchronous feeding, it is subclassed in to left side stitching bed and right side stitching bed to meet with sewing requirement. It is available for sewing large and cubic articles with small radius. It features easy stitch regulation, easy reverse feeding, smooth sewing and beautiful stitches.

用途/Usage:

- 特别适用于缝制皮鞋,靴子,箱包,高尔夫球袋等中厚料物品。
- It especially available for sewing on medium heavy weight articles with small radius, such as superior leather shoes, boots, suitcase, bags, golf bags, etc.

参数/Parameter:

最高缝速	最大缝目	机针
Max Sewing Speed	Max Stitch Length	Needle
1600 S.P.M	7MM	DPX17

BW-8367

360度旋转单针高头车
360°rotation Single Needle High Post Bed Machine

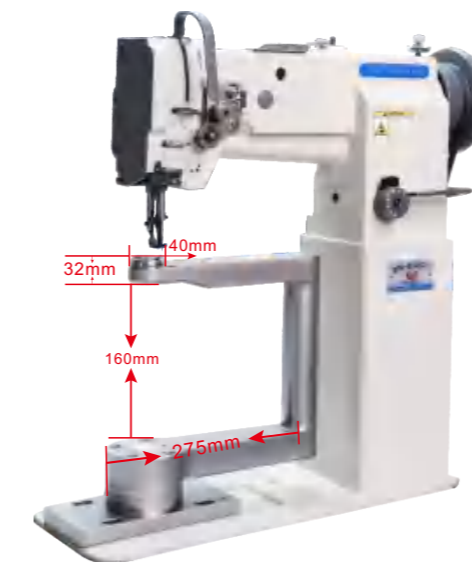

特点/Character:

- 采用三同步综合送料方式,根据缝制需要分为左釜座和右釜座。适用于缝制大型立体及小曲度的物品,针距调节,倒缝操作简单方便,线迹稳定美观。
- 采用360度旋转臂,便于方便对箱包的车缝,效果更佳。
- Using three synchronous feeding, it is subclassed in to left side stitching bed and right side stitching bed to meet with sewing requirement. It is available for sewing large and cubic articles with small radius. It features easy stitch regulation, easy reverse feeding, smooth sewing and beautiful stitches.
- Using 360° Rotation Arm. It's easier and more convenient on luggage bag sewing.

用途/Usage:

- 特别适用于缝制皮鞋,靴子,箱包,高尔夫球袋等中厚料物品。
- It especially available for sewing on medium heavy weight articles with small radius, such as superior leather shoes, boots, suitcase, bags, golf bags, etc.

参数/Parameter:

最高缝速	最大缝目	机针
Max Sewing Speed	Max Stitch Length	Needle
1600 S.P.M	7MM	DPX17

BW-H7

单针步进马达直驱滚轮上下送料平缝缝纫机

Single Needle Stepped Motor Direct Drive Flat Bed Sewing Machine With Upper And Lower Roller Feed



特点/Character:

- 采用多轴步进一体式伺服控制系统
- 步进驱动送料，倒缝功能中的针孔“不会错位”
- 多种装饰与组合缝线
- 缝线长度用控制面板需入
- 倒缝针数通过控制面板需入
- 差动送料
- Adopt multi-axis step integration servo control system
- Step drive feed, stitch in stitch in the backtacking function does not misplace.
- Various decorative and securing seams
- Seam length programming by control panel
- Number of backtack stitches by control panel
- Active differential feed

用途/Usage:

- 适用于皮革、棉织物、帆布制品如汽车座垫、袋子、鞋、帐篷、室内装饰品等厚料产品之平缝。
- It is suitable for sewing heavy material, such as artificial leather, sponge cloth, canvas car seat, bag, shoes, tent, upholstery etc.

参数/Parameter:

最高缝速	最大缝目	针杆行程	机针
Max. Sewing Speed	Max. Stitch Length	Needle Bar Stroke	Needle
2500 S.P.M	5MM	41MM	DPX5 16#

BW-8366

直驱单针综合送高头车（左右釜）

Direct Drive Single Needle Compound Feed High Post Bed Sewing Machine (Left & Right Hand Side Hook Available)



特点/Character:

- 采用三同步综合送料方式，根据缝制需要分为左釜座和右釜座。适用于缝制大型立体及小曲度的物品，针距调节，倒缝操作简单方便，线迹稳定美观。
- Using three synchronous feeding, it is subclassed in to left side stitching bed and right side stitching bed to meet with sewing requirement. It is available for sewing large and cubic articles with small radius. It features easy stitch regulation, easy reverse feeding, smooth sewing and beautiful stitches.

用途/Usage:

- 特别适用于缝制皮鞋、靴子、箱包、高尔夫球袋等中厚料物品。
- It especially available for sewing on medium heavy weight articles with small radius, such as superior leather shoes, boots, suitcase, bags, golf bags, etc.

参数/Parameter:

最高缝速	最大缝目	机针
Max Sewing Speed	Max Stitch Length	Needle
1600 S.P.M	7MM	DPX17

BW-8367Z

直驱360°旋转单针高头车

Direct Drive 360° Rotation Single Needle High Post Bed Sewing Machine



特点/Character:

- 采用三同步综合送料方式，根据缝制需要分为左釜座和右釜座。适用于缝制大型立体及小曲度的物品，针距调节，倒缝操作简单方便，线迹稳定美观。
- 采用360度旋转臂，便于方便对箱包的车缝，效果更佳。
- Using three synchronous feeding, it is subclassed in to left side stitching bed and right side stitching bed to meet with sewing requirement. It is available for sewing large and cubic articles with small radius. It features easy stitch regulation, easy reverse feeding, smooth sewing and beautiful stitches.
- Using 360° Rotation Arm. It's easier and more convenient on luggage bag sewing.

用途/Usage:

- 特别适用于缝制皮鞋、靴子、箱包、高尔夫球袋等中厚料物品。
- It especially available for sewing on medium heavy weight articles with small radius, such as superior leather shoes, boots, suitcase, bags, golf bags, etc.

参数/Parameter:

最高缝速	最大缝目	机针
Max Sewing Speed	Max Stitch Length	Needle
1600 S.P.M	7MM	DPX17

BW-20U43/53/63/93

20U曲折人字缝纫机

Single Needle Zigzag Sewing Machine.



特点/Character:

- 针位可左中右调节,形成绚丽多彩的装饰图案。
- Needle position can be left, middle and right, can sew a colorful patte

用途/Usage:

- 可在薄、中、厚料上做装饰绣缝,适用于服装,鞋帽,箱包等。
- Available in thin,standard, thick material sewing, suitable for garments,shoes,hat , cases etc.

参数/Parameter:

最高缝速	最大缝目	最大摆幅	机针
Max Sewing Speed	Max Stitch Length	Max Sewing	Needle
2000 S.P.M	5MM	0-9MM	DPX5

BW-20U93Z

20U直驱自动加油系列

Direct Drive Automatic Oil Lubrication Zigzag Sewing Macrin



特点/Character:

- 采用直驱马达,使机头和马达一体,不占空间,外形更加美观,车缝更加平稳。且非常节能省电。
- 自动加油系统。针位可左中右调节。形成绚丽多彩的装饰图案。
- Use direct drive motor, make machine head and motor together, savespace, looks more beautiful and sew more steady. Very energy efficient. Automatic oil lubrication system, needle position can be left, middle and right, can sew a colorful pattern.

用途/Usage:

- 可在薄、中、厚料上做装饰绣缝,适用于服装,鞋帽,箱包等。
- Available in thin,standard, thick material sewing, suitable for garments,shoes,hat , cases etc.

参数/Parameter:

最高缝速	最大缝目	最大摆幅	机针
Max Sewing Speed	Max Stitch Length	Max Sewing	Needle
2000 S.P.M	5MM	0-9MM	DPX5

BW-20U-A2

20U电脑系列

Intelligent Zigzag Sewing Machine



特点/Character:

- 本机是直接操作面板按键进行缝幅和缝样选择,并有记忆功能。机器自带190种花样,针位可左中右调节,形成绚丽多彩的装饰图案。
- This machine could choose stitching width and samples on panel, and gotmemory. It has 190 patterns, needle position can be left, middle and right,can sew a colorful pattern.

用途/Usage:

- 可在薄、中、厚料上做装饰绣缝,适用于服装,鞋帽,箱包等。
- Available in thin,standard, thick material sewing, suitable for garments,shoes,hat , cases etc.

参数/Parameter:

最高缝速	最大缝目	最大摆幅	机针
Max Sewing Speed	Max Stitch Length	Max Sewing	Needle
2000 S.P.M	5MM	0-9MM	DPX5

BW-1530/1533/1534

自动加油曲折缝机器(大梭)

Automatic Oil Lubrication Zig Zag Sewing Machine (large Hook)



特点/Character:

- 全自动供油系统,使零件不易磨损,大大降低了车缝时产生的噪音,增加本机寿命。采用双倍大釜与梭心,减少底线更换时间,提高生产效率。
- Fully automation Lubrication assures less friction on machine parts with increase the life of the machine, and lower the noise when sewing. Adopt double size large shuttle and bobbin, save the time for changing the thread, improving production efficiency.

用途/Usage:

- 特别适用于缝制皮鞋,布袋,手套等中厚料物品。
- It especially available for sewing on medium heavy weight articles with small radius, such as superior leather shoes, handbags, gloves, etc.

参数/Parameter:

最高缝速	最大缝目	最大摆幅	机针
Max Sewing Speed	Max Stitch Length	Max Sewing	Needle
2000 S.P.M	8MM	0-9MM	DPX5 DPX7

BW-1530Z

直驱自动加油曲折缝机器(大梭)

Direct Drive Automatic Oil Lubrication Zigzag Sewing Machine (large Hook)



特点/Character:

- 全自动供油系统,使零件不易磨损,大大降低了车缝时产生的噪音,增加本机寿命。
- 采用双倍大釜与梭心,减少底线更换时间,提高生产效率。
- 采用直驱马达,使机头和马达一体,不占空间,外形更加美观,车缝更加平稳。且非常节能省电。
- Fully automation Lubrication assures less friction on machine parts with increase the life of the machine, and lower the noise when sewing.
- Adopt double size large shuttle and bobbin, save the time for changing the thread, improving production efficiency.
- Use direct drive motor, make machine head and motor together, save space, looks more beautiful and sew more steady. Very energy efficient.

用途/Usage:

- 特别适用于缝制皮鞋,包袋,手套,等中厚料物品。
- It especially available for sewing on medium heavy weight articles with small radius, such as superior leather shoes, handbags, gloves, etc.

参数/Parameter:

最高缝速	最大缝目	最大摆幅	机针
Max Sewing Speed	Max Stitch Length	Max Sewing	Needle
2000 S.P.M	8MM	0-9MM	DPX5 DPX7

BW-1530BT

自动剪线电脑拼缝车(大梭)

Automatic Thread Trimming Computer Zigzag Sewing Machine (large hook)



特点/Character:

- 全自动供油系统,使零件不易磨损,大大降低了车缝时产生的噪音,增加本机寿命。
- 采用双倍大釜与梭心,减少底线更换时间,提高生产效率。
- 采用直驱马达,使机头和马达一体,不占空间,外形更加美观,车缝更加平稳。且非常节能省电。
- Fully automation Lubrication assures less friction on machine parts with increase the life of the machine, and lower the noise when sewing.
- Adopt double size large shuttle and bobbin, save the time for changing the thread, improving production efficiency.
- Use direct drive motor, make machine head and motor together, save space, looks more beautiful and sew more steady. Very energy efficient.

用途/Usage:

- 特别适用于缝制皮鞋,包袋,手套,等中厚料物品。
- It especially available for sewing on medium heavy weight articles with small radius, such as superior leather shoes, handbags, gloves, etc.

参数/Parameter:

最高缝速	最大缝目	最大摆幅	机针
Max Sewing Speed	Max Stitch Length	Max Sewing	Needle
2000 S.P.M	8MM	0-9MM	DPX5 DPX7

BW-2530

双压脚曲折缝纫机(大梭)

Double Presser Foot Zig Zag Sewing Machine(Large Hook)



特点/Character:

- 全自动供油系统,使零件不易磨损,大大降低了车缝时产生的噪音,增加本机寿命。
- 采用双倍大釜与梭心,减少底线更换时间,提高生产效率。
- Fully automation Lubrication assures less friction on machine parts with increase the life of the machine, and lower the noise when sewing. Adopt double size large shuttle and bobbin, save the time for changing the thread, improving production efficiency.

用途/Usage:

- 特别适用于缝制皮鞋,包袋,手套,等中厚料物品。
- It especially available for sewing on medium heavy weight articles with small radius, such as superior leather shoes, handbags, gloves, etc.

参数/Parameter:

最高缝速	最大缝目	最大摆幅	机针
Max Sewing Speed	Max Stitch Length	Max Sewing	Needle
2000 S.P.M	8MM	0-9MM	DPX5

BW-2530Z

直驱自动加油双压脚曲折缝纫机(大梭)

Direct Drive Double Presser Foot Zig Zag Sewing Machine(Large Hook)



特点/Character:

- 全自动供油系统,使零件不易磨损,大大降低了车缝时产生的噪音,增加本机寿命。
- 采用双倍大釜与梭心,减少底线更换时间,提高生产效率。
- Fully automation Lubrication assures less friction on machine parts with increase the life of the machine, and lower the noise when sewing. Adopt double size large shuttle and bobbin, save the time for changing the thread, improving production efficiency.

用途/Usage:

- 特别适用于缝制皮鞋,包袋,手套,等中厚料物品。
- It especially available for sewing on medium heavy weight articles with small radius, such as superior leather shoes, handbags, gloves, etc.

参数/Parameter:

最高缝速	最大缝目	最大摆幅	机针
Max Sewing Speed	Max Stitch Length	Max Sewing	Needle
2000 S.P.M	8MM	0-9MM	DPX5

BW-2150

大梭小嘴曲折缝车
Large Hook Small Mouth ZigZag Machine

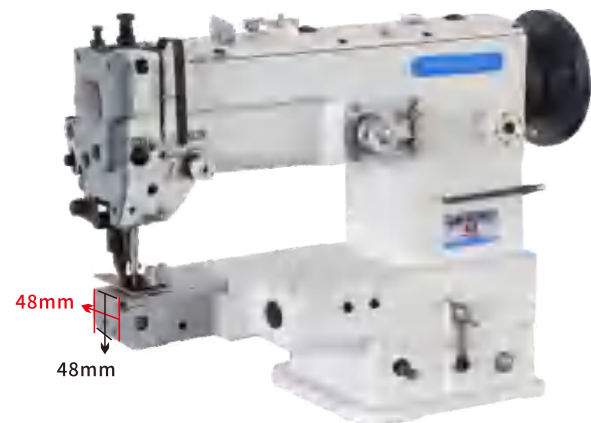

特点/Character:

- 上下送料, 自动供油系统。减少换线频率, 提高生产效率。因头部尺寸较小, 对儿童运动鞋缝纫时更流畅。
- Automatic lubrication. save the time for changing the thread, improving production efficiency. As to the small head, it's very smooth when sewing children's sports shoes.

用途/Usage:

- 适用于各种鞋面的曲折缝制包边。
- Suitable for sewing all kinds of shoes upper zigzag for binding.

参数/Parameter:

最高缝速	最大缝目	最大摆幅	机针
Max Sewing Speed	Max Stitch Length	Max Sewing	Needle
2000 S.P.M	4.5MM	0-9MM	DPX5 DPX7

BW-2150Z

直驱大梭小嘴曲折缝车
Direct drive Large Hook Small Mouth ZigZag Machine

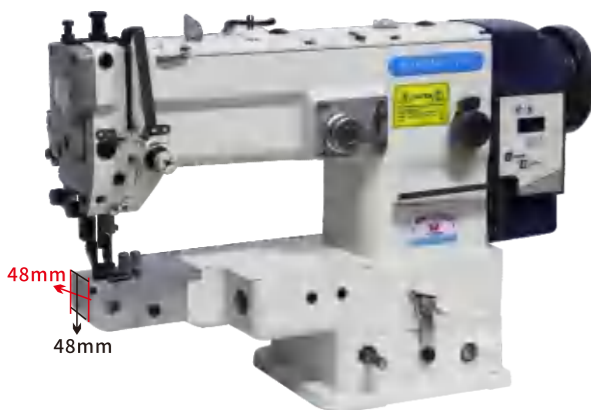

特点/Character:

- 上下送料, 自动供油系统。减少换线频率, 提高生产效率。因头部尺寸较小, 对儿童运动鞋缝纫时更流畅。
- Automatic lubrication. save the time for changing the thread, improving production efficiency. As to the small head, it's very smooth when sewing children's sports shoes.

用途/Usage:

- 适用于各种鞋面的曲折缝制包边。
- Suitable for sewing all kinds of shoes upper zigzag for binding.

参数/Parameter:

最高缝速	最大缝目	最大摆幅	机针
Max Sewing Speed	Max Stitch Length	Max Sewing	Needle
2000 S.P.M	4.5MM	0-9MM	DPX5 DPX7

BW-3150

单压脚立柱式曲折缝
Single Presser Foot Post Bed Zigzag Sewing Machine



特点/Character:

- 全自动供油系统, 使零件不易磨损, 大大降低了车缝时产生的噪音, 增加本机寿命。采用双倍大釜与梭心, 减少底线更换时间, 提高生产效率。
- Fully automation Lubrication assures less friction on machine parts with increase the life of the machine, and lower the noise when sewing. Adopt double size large shuttle and bobbin, save the time for changing the thread, improving production efficiency.

用途/Usage:

- 特别适用于缝制皮鞋, 包袋, 手套等中厚料物品。
- It especially available for sewing on medium heavy weight articles with small radius, such as superior leather shoes, handbags, gloves, etc.

参数/Parameter:

最高缝速	最大缝目	最大摆幅	机针
Max Sewing Speed	Max Stitch Length	Max Sewing	Needle
2000 S.P.M	8MM	0-9MM	DPX5 DPX17

BW-335A

单针综合送筒型车
Single Needle Cylinder Bed Sewing Machine with Unison Feed



特点/Character:

- 综合送料, 运转肃静, 在缝制时皆很稳定, 几层布料重叠缝制时, 内层不会移动。新型针柱座在缝制时比较稳定, 可减少断针及断线, 并可缝制较美观的线路。
- For unison feed, no matter the material surface is either smooth or rough, it can sew steadily. The inner layer won't move, even several material sew together. The new needle clamp is very steady, it can help to reduce breaking needle and yarns, and sew a beautiful stitching.

用途/Usage:

- 用于鞋类、皮包、皮带等的滚边车缝。
- Used for sewing shoes, bags, belts etc.

参数/Parameter:

最高缝速	最大缝目	圆筒直径	机针
Max Sewing Speed	Max Stitch Length	Diameter of Postbed	Needle
2000 S.P.M	4.5MM	46MM	DPX5 DPX7

BW-335N

单针综合送筒型车(气动自动切带)
Single Needle Cylinder Bed Compound Feed Sewing Machine (Pneumatic Tape Cutting)



特点/Character:

- 综合送料,运转肃静,在缝制时皆很稳定,几层布料重叠缝制时,内层不会移动。新型针柱座在缝制时比较稳定,可减少断针及断线,并可缝制较美观的线路。
- 自动切带,减少人工时间提升工作效率。
- 4倍大釜大大减少了更换梭心时间大幅度提升工作效率。
- For unison feed, no matter the material surface is either smooth or rough, it can sew steadily. The inner layer won't move, even several material sew together. The new needle clamp is very steady, it can help to reduce breaking needle and yarns and sew a beautiful stitching.
- Automatic tape cutting, no manual cutting required. Saving time and increasing productivity.
- 4 times big hook equipped, greatly reduce numbers of bobbin changes, and sharply improve work efficiency.

用途/Usage:

- 用于鞋类、皮包、皮带等的滚边车缝。
- Suitable for sewing all kinds of shoes upper zigzag for binding.

参数/Parameter:

最高缝速	最大缝目	圆筒直径	机针
Max Sewing Speed	Max Stitch Length	Diameter of Postbed	Needle
2000 S.P.M	4.5MM	46MM	DPX5 DPX7

BW-PF335

单针综合送筒型车(百福款)
Single Needle Cylinder Bed Compound Feed Sewing Machine (PFAFF Style)



特点/Character:

- 本机是最新款筒型送料平缝车。采用滑杆式挑线,连杆式送料机。上下轴高精度螺旋伞齿轮转动,自动加油润滑系统。减少零件磨损,增加使用寿命。综合送料线迹美观整齐。
- The machine is the newest cylinder unison feed sewing machine. Using the slider-style jumper and link-type feeding mechanism. The upper and lower shaft of high precision spiral bevel with gear transmission and automatic smooth refueling system. Increase the service life of parts to reduce wear and tear. Compound feed stitched in good order and beautiful.

用途/Usage:

- 缝制箱包,坐垫,皮革等。
- Used for sewing suitcase, cushion, leather etc.

参数/Parameter:

最高缝速	最大缝目	圆筒直径	机针
Max Sewing Speed	Max Stitch Length	Diameter of Postbed	Needle
2000 S.P.M	4.5MM	46MM	DPX5 DPX7

BW-2688

单针双倍大釜综合送筒型车(自动加油)
Single Needle Double Hook Cylinder Bed Sewing Machine with Unison Feed (Auto Refueling)



特点/Character:

- 本机是最新款筒型送料平缝车。采用滑杆式挑线,连杆式送料机。上下轴高精度螺旋伞齿轮转动,自动加油润滑系统。减少零件磨损,增加使用寿命。综合送料线迹美观整齐。
- The machine is the newest cylinder unison feed sewing machine. Using the slider-style jumper and link-type feeding mechanism. The upper and lower shaft of high precision spiral bevel with gear transmission and automatic smooth refueling system. Increase the service life of parts to reduce wear and tear. Compound feed stitched in good order and beautiful.

用途/Usage:

- 缝制箱包,坐垫,皮革等。
- Used for sewing suitcase, cushion, leather etc.

参数/Parameter:

最高缝速	最大缝目	圆筒直径	机针
Max Sewing Speed	Max Stitch Length	Diameter of Postbed	Needle
2000 S.P.M	6-8MM	50MM	DPX17

BW-2688Z

直驱单针双倍大釜综合送筒型车(自动加油)
Direct drive Single Needle Double Hook Cylinder Bed Sewing Machine with Unison Feed (Auto Refueling)



特点/Character:

- 本机是在原335的基础上延伸的最新款筒型送料平缝车。采用滑杆式挑线,连杆式送料机。上下轴高精度螺旋伞齿轮转动,自动加油润滑系统。减少零件磨损,增加使用寿命。综合送料线迹美观整齐。同335部分零件通用,售后服务更加方便快捷。
- The machine is the newest cylinder unison feed sewing machine on above BW-335 sewing machine. Using the slider-style jumper and link-type feeding mechanism. The upper and lower shaft of high precision spiral bevel with gear transmission and automatic smooth refueling system. Increase the service life of parts to reduce wear and tear. Compound feed stitched in good order and beautiful. Same as BW-553, parts of accessories could be used on two machines, after-sale service is more convenient and efficient.

用途/Usage:

- 缝制箱包,坐垫,皮革等。
- Used for sewing suitcase, cushion, leather etc.

参数/Parameter:

最高缝速	最大缝目	圆筒直径	机针
Max Sewing Speed	Max Stitch Length	Diameter of Postbed	Needle
2000 S.P.M	6MM	50MM	DPX17

BW-PF335Z

直驱单针综合送筒型车（百福款）

Direct Drive Single Needle Compound Feed Cylinder Bed Sewing Machine (PFAFF Style)



特点/Character:

- ◎ 本机是最新款筒型送料平缝车。采用滑杆式挑线，连杆式送料机。上下轴高精度螺旋伞齿轮转动，自动加油润滑系统。减少零件磨损，增加使用寿命。综合送料线迹美观整齐。
- ◎ The machine is the newest cylinder unison feed sewing machine. Using the slider-style jumper and link-type feeding mechanism. The upper and lower shaft of high precision spiral bevel with gear transmission and automatic smooth refueling system. Increase the service life of parts to reduce wear and tear. Compound feed stitched in good order and beautiful.

用途/Usage:

- ◎ 缝制箱包,坐垫,皮革等。
- ◎ Used for sewing suitcase, cushion, leather etc.

参数/Parameter:

最高缝速	最大缝目	圆筒直径	机针
Max Sewing Speed	Max Stitch Length	Diameter of Postbed	Needle
2000 S.P.M	4.5MM	46MM	DPX5 DPX7

BW-PF335BT

直驱综合送料筒式缝纫机

Direct Drive Compound Feed Cylinder Lockstitch Sewing Machine



特点/Character:

- ◎ 采用直驱式内置马达
- ◎ 剪线/倒缝/抬压脚采用电磁铁驱动
- ◎ 圆筒直径小梭46.5MM、大梭50MM，缝纫筒状物料转动灵活。
- ◎ 采用大旋梭，减少了更换梭芯的次数（大旋梭）。
- ◎ 采用同步移动、水平式下送料和包边装置，缝料的包边匀称整齐。
- ◎ 噪音小，经久耐用。
- ◎ Adopt direct drive built-in motor.
- ◎ Adopt solenoid drive thread trimming, backstitch, presser foot lifting.
- ◎ The diameter of cylinder for small hook is 46.5MM, for large hook is 50MM, and turning around the cylindrical materials lightly.
- ◎ Adopt large hook, reduce the replacement times of bobbin (for large hook) .
- ◎ Adopt synchronous moving, horizontal lower feed and overcast stitching device, and the overcast stitching of materials is symmetrical and orderly.
- ◎ Low noise, and durable.

用途/Usage:

- ◎ 适用于皮革、棉织物、帆布制品如汽车坐垫、袋子、鞋、帐篷、室内装饰品等厚料产品之平缝。
- ◎ It is suitable for sewing heavy material, such as artificial leather, sponge cloth, canvas car seat, bag, shoes, tent, upholstery etc.

参数/Parameter:

最高缝速	最大缝目	针杆行程	机针
Max. Sewing Speed	Max. Stitch Length	Needle Bar Stroke	Needle
2500 S.P.M	6MM	33.5MM	DPX17

BW-8B

单针综合送筒型

Single Needle Cylinder Bed Compound Feed Sewing Machine



特点/Character:

- ◎ 本机是专为箱包制造业设计的筒式厚料平缝机。采用滑杆挑线，立式旋梭勾线，构成双线锁式线迹。上下轴用同步齿形带传动：压脚，送布牙，机针同时送料，杠杆式针距调节机构。高压脚行程，高压脚提升间隙和大的线迹长度，配合筒型缝台。
- ◎ The machine is specially designed for luggage manufacturing cylindrical thick flat sewing machine. It is designed with sliding lever thread take-up, vertical rotating hook, cog band for driving arm shaft and hook shaft, compound feed by presser foot, feed dog and needle, lever type stitch regulator. With high presser foot lift. Long stitch and cylinder bed.

用途/Usage:

- ◎ 用于缝制厚重包袋，行李箱，坐垫，特别适用于箱包的周边作业。
- ◎ Used for sewing heavy bags, luggage, seat cushion, especially for edge seaming on luggage bags.

参数/Parameter:

最高缝速	最大缝目	圆筒直接	机针
Max Sewing Speed	Max Stitch Length	Diameter of Postbed	Needle
2000 S.P.M	6MM	65MM	DPX17

BW-8B-A2

单针综合送筒型电脑车

Single Needle Cylinder Bed Computer Sewing Machine with Unison Feed



特点/Character:

- ◎ 本机是最新款筒型送料平缝车。采用滑杆式挑线，连杆式送料机。上下轴高精度螺旋伞齿轮转动，自动加油润滑系统。减少零件磨损，增加使用寿命。综合送料线迹美观整齐。
- ◎ The machine is the newest cylinder unison feed sewing machine. Using the slider-style jumper and link-type feeding mechanism. The upper and lower shaft of high precision spiral bevel with gear transmission and automatic smooth refueling system. Increase the service life of parts to reduce wear and tear. Compound feed stitched in good order and beautiful.

用途/Usage:

- ◎ 用于缝制厚重包袋，行李箱，坐垫，特别适用于箱包的周边作业。
- ◎ Used for sewing suitcase, cushion, leather etc.

参数/Parameter:

最高缝速	最大缝目	圆筒直接	机针
Max Sewing Speed	Max Stitch Length	Diameter of Postbed	Needle
2000 S.P.M	6MM	65MM	DPX17

BW-246

单针综合送筒型车

Single-needle Compound Feed Cylinder Sewing Machine



特点/Character:

- ◎ 采用三同步综合送料，缝制厚薄物品，均匀美观。改良新型结构设计。增加使用性能，操作时更加方便。适用于包袋、玩具、文具等各种物料的车缝。
- ◎ This machine adopts a new method of rectangular compound feed that makes stitching nice and smooth, which allows it to sew a broad range of heavy and light materials. So it is especially available in stitching packages, toys, stationery and other similar goods.

用途/Usage:

- ◎ 用于缝制厚重包袋，行李箱，坐垫，特别适用于箱包的周边作业。
- ◎ Used for sewing heavy bags, luggage, seat cushion, especially for edge seaming on luggage bags.

参数/Parameter:

最高缝速	最大缝目	圆筒直接	机针
Max Sewing Speed	Max Stitch Length	Diameter of Postbed	Needle
2000 S.P.M	6MM	65MM	DPX17

BW-246Z

直驱单针综合送筒型电脑车

Direct drive Single Needle Cylinder Bed Computer Sewing Machine with Unison Feed



特点/Character:

- ◎ 本机是最新款筒型送料平缝车。采用滑杆式挑线，连杆式送料机。上下轴高精度螺旋伞齿轮转动，自动加油润滑系统。减少零件磨损，增加使用寿命。综合送料线迹美观整齐。
- ◎ The machine is the newest cylinder unison feed sewing machine. Using the slider-style jumper and link-type feeding mechanism. The upper and lower shaft of high precision spiral bevel with gear transmission and automatic smooth refueling system. Increase the service life of parts to reduce wear and tear. Compound feed stitched in good order and beautiful.

用途/Usage:

- ◎ 用于缝制厚重包袋，行李箱，坐垫，特别适用于箱包的周边作业。
- ◎ Used for sewing suitcase, cushion, leather etc.

参数/Parameter:

最高缝速	最大缝目	圆筒直接	机针
Max Sewing Speed	Max Stitch Length	Diameter of Postbed	Needle
2000 S.P.M	6MM	65MM	DPX17

BW-341

筒式自动加油综合送料缝纫机

Auto Lubrication Compound Feed Sewing Machine



特点/Character:

- 综合送料,大旋梭,流线型针板。专为箱包制造设计的筒式厚料平缝机。
- Compound Feed, Large Hook, streamline type needle plate. Designed for manufacture of luggage box thick material sewing machine.

用途/Usage:

- 用于缝制箱包、皮带、坐垫等。
- Used for sewing suitcase, bags, belts and cushion etc.

参数/Parameter:

最高缝速	最大缝目	圆筒直径	机针
Max Sewing Speed	Max Stitch Length	Diameter of Postbed	Needle
2000 S.P.M	9MM	70MM	DPX17

BW-323

内里修边机

Edge Trimming Machine



特点/Character:

- 用于鞋面内里的修剪,鞋底毛边的修剪。操作简单
- Suitable for trimming edge of vamp lining products. Easy to operate.

用途/Usage:

- 适用于马靴,运动鞋,凉鞋等。
- Suitable for boots, sport shoes, leisure shoes.

参数/Parameter:

马达:1/2HP离合器马达
Motor: 1/2HP Clutch Motor

BW-323Z

直驱内里修边机

Direct Drive Edge Trimming Machine



特点/Character:

- 用于鞋面内里的修剪,鞋底毛边的修剪。操作简单
- Compound Suitable for trimming edge of vamp lining products. Easy to operate.

用途/Usage:

- 适用于马靴,运动鞋,凉鞋等。
- Suitable for boots, sport shoes, leisure shoes.

参数/Parameter:

马达:1/2HP离合器马达
Motor: 1/2HP Clutch Motor

BW-801

削皮机

Skiving Machine



特点/Character:

- 该器具具有高精度,耐久性。磨刀器可以保证刀口始终锋利无比。附自动除屑装置。调整方便,操作简单。
- The high quality material & increase the durability and function. Knife sharpener can ensure knife edge always sharp. With automatic removing device. Easy to adjust and operate.

用途/Usage:

- 适用于各种皮革和橡胶等材料的表面削薄。
- Suitable for edge thinning and surface thinning of all kinds of leather and rubber, and other materials.

参数/Parameter:

最大宽幅	最高转速	马达
Max Width	Max Speed	Motor
50MM	1200 S.P.M.	1/2HP Clutch Motor

BW-801H

重力型削皮机
Gravity Type Skiving Machine



特点/Character:

- 采用连杆传动, 滚轮送料, 遇到较厚的物料时, 送料可随着物料上下自动调节, 从而减轻了机器磨损。特殊药水喷洒方式, 采用电磁阀控制, 可任意调节药水喷洒时间, 有效防止刀口粘缠, 提高了生产效率, 防止圆刀, 机器生锈。
- Using the connection rod drive, rolling wheel feeding. When sewing thicker material, feeding can adjusted automatically along with the material up and down, thus reducing the machine wear. Special potion the spraying mode, use electromagnetic valve control, can be arbitrarily adjust potion spraying time, effectively prevent knife mouth adhesion, improve production efficiency, prevent round knife, machine rust.

用途/Usage:

- 主要用于各种皮革, 橡胶, EVA 材料等的修薄。
- Mainly used for skiving all kinds of leather, rubber, EVA material, etc.

参数/Parameter:

最高转速	马达
Max Speed	Motor
1200 S.P.M.	1/2HP Clutch Motor

BW-801Z

电子调速直驱一体削皮机
Electronic Speed Direct Drive All In One Skiving Machine



特点/Character:

- 该器具具有高精度, 耐久性。磨刀器可以保证刀口始终锋利无比, 附自动除屑装置。调整方便, 操作简单。
- The high quality material & increase the durability and function. Knife sharpener can ensure knife edge always sharp. With automatic removing device. Easy to adjust and operate.

直驱马达特点/Direct Drive Motor Features:

- 送料机构可以调速, 圆刀可正反转, 根据不同的材料选择不同的速度, 使所有材料都能均匀削料。
- Feeding mechanism can adjust speed, round knife can be reversed, according to different materials to choose a different speed, so that all materials can be completed skiving.

控制系统/Control System:

- 拥有详细的控制面板, 可轻松应对磨刀, 送料机构, 圆刀的调速与换向, 避免了传统调试耗时长、调不到位的缺点。
- Has a detail control panel, can easily deal with sharpening, feeding agencies, round knife speed and commutation, to avoid the traditional debugging time-consuming, can not in place to point.

BW-0302

单针双压脚上下同步送平车
(双倍大釜&自动加油)

Single Needle Double Presser Feet Lock-stitch Sewing Machine with Top and Bottom Feed (Double Large Hook & Auto Lubrication)



特点/Character:

- 双压脚与送步牙交互上下送料, 确保车缝效果均匀美观。采用双倍大釜与梭心, 减少底线更换时间, 提高生产效率。全自动加油循环系统, 能有效降低零件的损耗, 减少车缝时产生的噪音。
- Double presser feet top and bottom feed to assure perfect stitching. Adopt double size large shuttle and bobbin, save the time for changing the thread, improving production efficiency. Fully automatic lubricating system can reduce the parts wastage and noise when sewing.

用途/Usage:

- 适用于缝制皮鞋、运动鞋、坐垫、箱包等中厚料物品。
- It available for sewing on medium heavy weight articles with small radius, such as leather shoes, sports shoes, pillow, cases and bags etc.

参数/Parameter:

最高缝速	最大缝目	机针
Max Sewing Speed	Max Stitch Length	Needle
2500 S.P.M	8MM	DPX17

BW-0303Z

直驱中厚料上下同步送料平缝机
Auto-Trimming Direct-Drive Lock-stitch Sewing Machine with Top and Bottom Feed



特点/Character:

- 本机采用连杆挑线, 大旋梭勾线, 自动润滑系统, 配置上下送料机构和压脚交替提升机构, 自动倒缝。缝厚能力强, 层缝性能好, 采用润滑装置, 噪音低, 使用寿命长。
- The machine is flat-bed type machine. It adopts link take-up and rotating hook, auto back tack. Low noise, easy maintenance and minimum difference in stitch length between forward and reverse feed. It equipped with top & bottom feeding mechanism, and walking foot.

用途/Usage:

- 适用于缝制皮鞋、运动鞋、坐垫、箱包等中厚料物品。
- It available for sewing on medium heavy weight articles with small radius such as leather shoes, sports shoes, pillow, cases and bags etc.

参数/Parameter:

最高缝速	最大缝目	机针
Max Sewing Speed	Max Stitch Length	Needle
2500 S.P.M	8MM	DPX17

BW-0303D

上下同步送料电脑平缝机(中厚料)

Lock-stitch Computer Sewing Machine with Top and Bottom Feed(Medium Heavy Articles)



特点/Character:

- ◎ 本机采用连杆挑线,大旋梭勾线,自动润滑系统,配置上下送料机构。自动剪线,自动倒缝。缝厚能力强,层缝性能好,采用润滑装置,噪音低、使用寿命长。
- ◎ The machine is flat-bed type machine. It adopts link take-up and rotating hook. Auto thread trimming & back tack. Low noise, easy maintenance and minimum difference in stitch length between forward and reverse feed. It equipped with top & bottom feeding mechanism, and walking foot.

用途/Usage:

- ◎ 适用于缝制皮鞋,运动鞋,坐垫,箱包等中厚料物品。
- ◎ It available for sewing on medium heavy weight articles with small radius, such as leather shoes, sports shoes, pillow, cases and bags etc.

参数/Parameter:

最高缝速	最大缝目	机针
Max Sewing Speed	Max Stitch Length	Needle
2500 S.P.M	8MM	DPX17

BW-0303M

上下同步送料电脑平缝机(中厚料一体机)

Lock-stitch Computer Sewing Machine with Top and Bottom Feed(Medium Heavy Articles and all-in-one machine)



特点/Character:

- ◎ 本机采用连杆挑线,大旋梭勾线,自动润滑系统,配置上下送料机构。自动剪线,自动倒缝。缝厚能力强,层缝性能好,采用润滑装置,噪音低、使用寿命长。
- ◎ The machine is flat-bed type machine. It adopts link take-up and rotating hook. Auto thread trimming & back tack. Low noise, easy maintenance and minimum difference in stitch length between forward and reverse feed. It equipped with top & bottom feeding mechanism, and walking foot.

用途/Usage:

- ◎ 适用于缝制皮鞋,运动鞋,坐垫,箱包等中厚料物品。
- ◎ It available for sewing on medium heavy weight articles with small radius, such as leather shoes, sports shoes, pillow, cases and bags etc.

参数/Parameter:

最高缝速	最大缝目	机针
Max Sewing Speed	Max Stitch Length	Needle
2500 S.P.M	8MM	DPX17

BW-747NF

电脑一体包缝机

Computer integrated overlock sewing machine



特点/Character:

- ◎ 本机采用连杆挑线,大旋梭勾线,自动润滑系统,配置上下送料机构。自动剪线,自动倒缝。缝厚能力强,层缝性能好,采用润滑装置,噪音低、使用寿命长。
- ◎ The machine is flat-bed type machine. It adopts link take-up and rotating hook. Auto thread trimming & back tack. Low noise, easy maintenance and minimum difference in stitch length between forward and reverse feed. It equipped with top & bottom feeding mechanism, and walking foot.

用途/Usage:

- ◎ 适用于缝制皮鞋,运动鞋,坐垫,箱包等中厚料物品。
- ◎ It available for sewing on medium heavy weight articles with small radius, such as leather shoes, sports shoes, pillow, cases and bags etc.

参数/Parameter:

最高缝速	最大缝目	机针
Max Sewing Speed	Max Stitch Length	Needle
2500 S.P.M	8MM	DPX17

BW-500

高速绷缝机

High Speed Interlock Sewing Machine



特点/Character:

- ◎ 本机采用连杆挑线,大旋梭勾线,自动润滑系统,配置上下送料机构。自动剪线,自动倒缝。缝厚能力强,层缝性能好,采用润滑装置,噪音低、使用寿命长。
- ◎ Equipped with full closed cold style, automatic lubrication system. Adopt movable protecting device to avoid stitch thread skipping and keep the beautiful stitch.

用途/Usage:

- ◎ 用于鞋面内里结合车缝和装饰缝。
- ◎ Used for shoes interlock and decoration sewing.

参数/Parameter:

最高缝速	最大缝目	机针
Max Sewing Speed	Max Stitch Length	Needle
5500 S.P.M	5MM	UY128GAS

BW-3800-1/2/3

高速直驱双针链式平缝机

Direct Drive High Speed Double Needle Chain Stitch Sewing Machine



特点/Character:

- ◎ 本机能同时缝出两行平行的双线链式线迹。有五种针间距可供选择。
- ◎ The machine can obtain two lines of parallel of double chain stitch seams simultaneously. The optional needle gauge has 5 specifications.

用途/Usage:

- ◎ 适用于服装、内衣、床上用品以及薄中厚料包和皮革制品的搭接、装饰缝。
- ◎ It is suitable for lap seaming and adorn seaming on garments, underwear, bedding, packages and leather goods.

参数/Parameter:

最高缝速	最大缝目	机针
Max Sewing Speed	Max Stitch Length	Needle
5000 S.P.M	4MM	DP X 7 9#-21#

BW-3812

直驱程序式缩缝机

Direct Drive Programmed Sewing Machine



特点/Character:

- ◎ 创新设计可设置ABA针数自动变换记忆功能,有效解决鞋头两侧因材料厚度差异造成缩缝效果不均问题
- ◎ 程序式电控参数设置,中英文语音导航功能,操作更加便利
- ◎ 勾针链缝结构设计,省去换底线时间有效提升生产效率。
- ◎ The innovative design can set up the ABA stitch number automatic change memory function, effectively solving the problem of uneven shrinkage seam effect caused by material thickness differences on both sides of the shoe toe. Programmed electronic control parameter setting, Chinese and English voice navigation function, making operation more convenient. The design of the hook needle chain stitch structure saves time for changing the bottom thread and effectively improves production efficiency.

用途/Usage:

- ◎ 适用制鞋、沙发、手套、皮革、布料产品缩缝。
- ◎ Suitable for sewing shoes, sofas, gloves, leather, and fabric products.

参数/Parameter:

No.							
型号 Model number	针数 Needle count	转数 Number of revolutions	压脚高度 Foot Height	针迹长度 Stitch length	机针型号 Needle type	勾针 Crochet	中厚料 Medium-thick stock
3811M	1	2000spm	15mm	3.0mm	4463KKD #18	*	*

BW-9800D

高速电脑平缝机

High Speed Computer Lock-stitch Machine



特点/Character:

- ◎ 直驱伺服马达,比普通机器省电70%以上,超大操作空间,采用优良的送布机械,在低张力的状态下能防止高速时的跳动,并自动剪线,抬压脚,倒缝,大大地提高了生产效率。美观大方,操作简便。低噪声,无辐射,环保型。
- ◎ The machine equipped with direct-drive servo motor. It can save 70% electricity compared with normal motor. Have grate working space. Adopt advanced feeding mechanism to prevent leaping when in low tension but high speed, and auto trimming, auto presser foot, auto reverse stitching, greatly improve production. The machine has the advantages of beautiful appearance, easily operation, lower noise, without radiation.

用途/Usage:

- ◎ 适用于缝制皮鞋,运动鞋,坐垫,箱包等中厚料物品。
- ◎ It available for sewing on medium heavy weight articles with small radius, such as leather shoes, sports shoes, pillow, cases and bags etc.

参数/Parameter:

最高缝速	最大缝目	机针
Max Sewing Speed	Max Stitch Length	Needle
4500 S.P.M	5MM	DBX1

BW-9800Z

高速电脑平缝机

High Speed stitch Computer Lock-stitch Machine



特点/Character:

- ◎ 直驱伺服马达,比普通机器省电70%以上,超大操作空间,采用优良的送布机械,在低张力的状态下能防止高速时的跳动,并自动剪线,抬压脚,倒缝,大大地提高了生产效率。美观大方,操作简便。低噪声,无辐射,环保型。
- ◎ The machine equipped with direct-drive servo motor. It can save 70% electricity compared with normal motor. Have grate working space. Adopt advanced feeding mechanism to prevent leaping when in low tension but high speed, and auto trimming, auto presser foot, auto reverse stitching, greatly improve production. The machine has the advantages of beautiful appearance, easily operation, lower noise, without radiation.

用途/Usage:

- ◎ 适用于缝制皮鞋,运动鞋,坐垫,箱包等中厚料物品。
- ◎ It available for sewing on medium heavy weight articles with small radius, such as leather shoes, sports shoes, pillow, cases and bags etc.

参数/Parameter:

最高缝速	最大缝目	机针
Max Sewing Speed	Max Stitch Length	Needle
4500 S.P.M	5MM	DBX1

BW-600

自动加油拉帮机

Auto Lubrication High Capacity String Lasting Machine



特点/Character:

- ◎ 自动加油润滑设计,减少零件损坏。可简单调整针距,方便操作。
- ◎ Auto Lubrication design, reduce parts damage. Can adjust needle distance, easy to operate.

用途/Usage:

- ◎ 用于运动鞋等鞋类的中底缝合。
- ◎ Use for side seam edge sewing of sports shoes, and other shoes.

参数/Parameter:

最高缝速	最大缝目	机针
Max Sewing Speed	Max Stitch Length	Needle
2800 S.P.M	8MM	DPX5

BW-600N

自动加油拉帮机(带缩头装置)

Auto-lubrication Insole Seaming Machine
(With Toe Cap Wrinkling Device)



特点/Character:

- ◎ 自动加油润滑设计,减少零件损坏。可简单调整针距,方便操作。
- ◎ Auto Lubrication design, reduce parts damage. Can adjust needle distance, easy to operate.

用途/Usage:

- ◎ 用于运动鞋等鞋类的中底缝合。
- ◎ Use for side seam edge sewing of sports shoes, and other shoes.

参数/Parameter:

最高缝速	最大缝目	机针
Max Sewing Speed	Max Stitch Length	Needle
2800 S.P.M	8MM	DPX5

BW-600Z

直驱自动加油拉帮机

Direct Drive Auto-lubrication Insole Seaming Machine



特点/Character:

- ◎ 自动加油润滑设计,减少零件损坏。可简单调整针距,方便操作。
- ◎ Auto Lubrication design, reduce parts damage. Can adjust needle distance, easy to operate.

用途/Usage:

- ◎ 用于运动鞋等鞋类的中底缝合。
- ◎ Use for side seam edge sewing of sports shoes, and other shoes.

参数/Parameter:

最高缝速	最大缝目	机针
Max Sewing Speed	Max Stitch Length	Needle
2800 S.P.M	8MM	DPX5

BW-600T

自动剪线拉帮机

Automatic Thread Trimming Computer Auto-lubrication Insole Seaming Machine



特点/Character:

- ◎ 自动加油润滑设计,减少零件损坏。可简单调整针距,方便操作。
- ◎ Auto Lubrication design, reduce parts damage. Can adjust needle distance, easy to operate.

用途/Usage:

- ◎ 用于运动鞋等鞋类的中底缝合。
- ◎ Use for side seam edge sewing of sports shoes, and other shoes.

参数/Parameter:

最高缝速	最大缝目	机针
Max Sewing Speed	Max Stitch Length	Needle
2800 S.P.M	8MM	DPX5

BW-4400

单针综合送厚料平缝机
Single Needle Heavy Duty Compound Feed Sewing Machine



特点/Character:

- ◎ 立式旋梭勾线,滑杆挑线。同步齿形带传送,柱塞式油泵润滑系统传动轻滑,噪音小,耐用度高。
- ◎ The machine uses a large vertical hook line, slider bar thread. Synchronous Toothed belt conveyor plunger pump lubrication system. Drive light slip, lownoise, high durability.

用途/Usage:

- ◎ 用于缝制箱包、沙发、皮带、坐垫等。
- ◎ Used for sewing suitcase, sofa, bags, belts and cushion etc.

参数/Parameter:

最高缝速	最大缝目	机针
Max Sewing Speed	Max Stitch Length	Needle
1800 S.P.M	6MM	DPX17

BW-4420 (L180/L457/L635)

长臂双针综合送厚料平缝机
Long Arm Double Needle Heavy Duty Compound Feed Sewing Machine



特点/Character:

- ◎ 立式旋梭勾线,滑杆挑线。同步齿形带传送,柱塞式油泵润滑系统传动轻滑,噪音小,耐用度高。
- ◎ The machine uses a large vertical hook line, slider bar thread. Synchronous Toothed belt conveyor plunger pump lubrication system. Drive light slip, lownoise, high durability.

用途/Usage:

- ◎ 用于缝制箱包、沙发、皮带、坐垫等。
- ◎ Used for sewing suitcase, sofa, bags, belts and cushion etc.

参数/Parameter:

最高缝速	最大缝目	机针
Max Sewing Speed	Max Stitch Length	Needle
1800 S.P.M	6MM	DPX17

BW-300D

热熔胶机
Hot Melt Glue Pasting Machine



用途/Usage:

- ◎ 制鞋行业、商标标签行业、纺织品复合行业、纸箱包装行业、纸品印刷装订行业 温材料粘合行业。
- ◎ Application scope Trademark label industry Shoe-making industry Textile composite industry Carton packaging industry Paper printing and binding industry

参数/Parameter:

加热槽容量:4L	Maximum sol rate:4L
最大溶胶速率:4L	Maximum operating temperature: 210 oC
最大操作温度:210 oC	Maximum viscosity used:20000CPS
最大使用粘稠度:20000CPS	Maximum coating width (paper carton, etc.):300mm
最大涂布(纸盒纸箱等)宽度:300mm	Coating thickness:0.2--10mm
涂布厚度:0.2--10mm	Machine size:505mm*932mm*465mm
器尺寸:505mm*932mm*465mm	Weight:75Kg
重量:75Kg	Voltage:220V
电压:220V	Motor power:90W
电机功率:90W	Heating power:255W
加热功率:255W	



BW-1000D

热熔胶机
Hot Melt Glue Pasting Machine

用途/Usage:

- ◎ 制鞋行业、一次性卫生行业、医疗卫生行业、商标标签行业、纺织品复合行业、纸箱包装行业、纸品印刷装订行业、家具粘合行业、食品包装行业、保温材料粘合行业、
- ◎ Shoe-making Industry, Disposable hygiene industry, Healthcare industry, Trademark label industry, Textile composite industry, Carton packaging industry, Paper printing and binding industry, Furniture bonding industry, Food packaging industry, Insulation material bonding industry

参数/Parameter:

◎ 加热槽容量:20L	◎ 最大溶胶速率:20L	◎ 最大操作温度:230 °C	◎ 最大使用粘稠度:20000CPS	◎ 最大涂布(纸盒纸箱等)宽度:1000mm
◎ 涂布厚度:300mm	◎ 器尺寸:505mm*932mm*465mm	◎ 重量:205Kg	◎ 电压:220V	◎ 电机功率:400W
◎ 加热功率:7150W	◎ Heating tank capacity:20L	◎ Maximum sol rate:20L	◎ Maximum operating temperature:230°C	Maximum viscosity used:20000CPS
◎ Maximum coating width (paper carton, etc.):1000mm	◎ Maximum coating thickness (paper carton, etc.):300mm	◎ Machine size with roller holder:1300*1025*546	◎ Machine size without roller holder:1300*670*546	
◎ Weight:205Kg	◎ Voltage:220V	◎ Motor power:400W	◎ Heating power:7150W	



BW-901

单针直驱罗拉车

Single Needle Direct Drive Roller Machine



BW-801Z

直驱电子调速削皮机配套吸尘器

Leather Skiving Machine

Direct Drive Electronic Speed Control Equipped With Scrap Suction Device



BW-901BT

单针自动电脑罗拉车

Single Needle Automatic Computerized Roller Machine



BW-902

双针直驱罗拉车

Double Needle Direct Drive Roller Machine



BW-902BT

双针自动电脑罗拉车

Double Needle Automatic Computerized Roller Machine



单针棒 Single Needle Stick



双针棒 Double Needle Stick



轮钱棒 Rotary stick



双针送金下轮
Double Needle
Feed Down Wheel



双针送金
Double Needle Feed



轮钱 Rotary



单针送金
Single Needle Feed



小针板
Small Needle Plate



单针板
Single Needle Plate



双针板
Double Needle Plate



大釜盖
Hook Cover



大釜
Hook



梭壳
Bobbin Case



梭心
Bobbin



单针沙拉组
Single Needle
Salad Group



双针沙拉组
Double Needle
Salad Group



牛角
Thread Wipe
Tool



压轮轴组
Press Wheel
Shaft Set



刀组
Knife Group



刀架
Knife Rest



单向轴承
One-way Bearing



针钮
Stitch Button



O型圈
O Ring



绕线器
Winder



万向连杆
Universal Connecting Shaft



同步带 Synchronous Belt



BW-26A



BW-27A



BW-41



BW-44A



BW-77



BW-80



BW-53



BW-79



BW-82

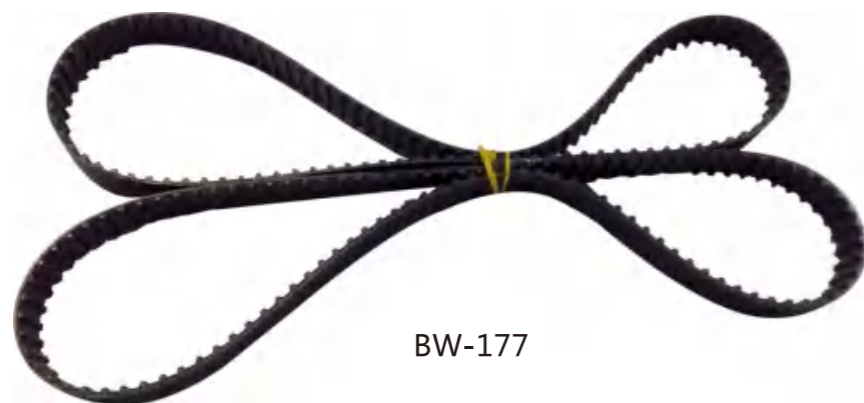

BW-177



BW-194



BW-216



BW-230



BW-241



BW-242



BW-244



BW-246



BW-271



BW-277



BW-278/279



BW-323-1



BW-323-2



BW-323-3



BW-323-4



BW-323-5



BW-323-6



BW-323-7



BW-323-8



BW-323-9



BW-323-10



BW-323Z(Direct Drive)-11



BW-335-1



BW-335-2

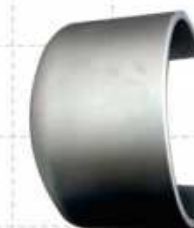

BW-335-3



BW-335-4



BW-335-5



BW-335-6



A



B



C



D

BW-335-7





BW-1530-1



BW-1530-2



BW-1530-3



BW-1530-4



BW-1530-5



BW-1530-6



BW-1530-7

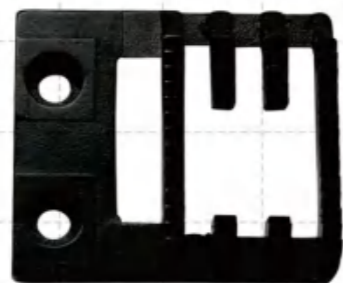

BW-1530-8



BW-1530-9



BW-1530-10



BW-1530-11

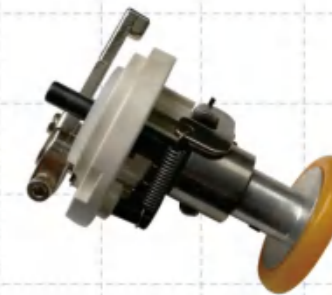

BW-1530-12



BW-1530-13



BW-1530-14

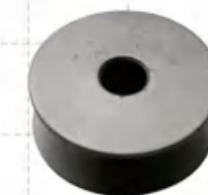

BW-1530-15



BW-1530-16



A

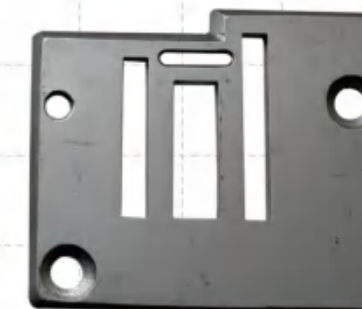

B

BW-2150-1



BW-2688-1



BW-2688-2

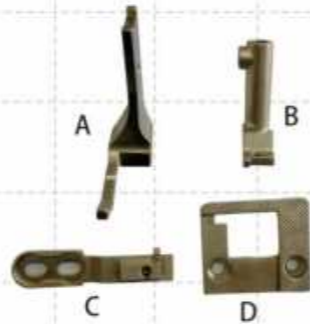

BW-2628-3



BW-2688-4



BW-2688-5



BW-2688-6



BW-2688-7



BW-2688-8

时代的步伐赋予了《天赢》更广阔的空间
“求精务实”、“和谐人文”的理念演绎着更深刻的“浦尔贝”文化。

十年磨一剑，带着一股锐意的创新和执着的信念。

我们在用心的描绘着一副理想的蓝图，并与各位同仁一起翱翔于广阔天地之间。

《天赢》是我们的，也是你们的！携手并进，共享双赢！

总经理：任贵致词

The pace of times gives "BORN WINNER" a broader space.
The whole staff in Purbeck hold the norm "Honesty. Harmonious" and we sincerely promised that we would provide our customers for satisfactory service and high quality product.

"Decade of sword". With a sense of innovation and conviction, we are drawing an ideal blueprint with our hearts. Create brilliance with like-minded partners.
"BORN WINNER" Belongs to you, and to me!
Let's go forward hand in hand and share a win-win situation.

General Manager: Rain

